

Cut Out And Stick

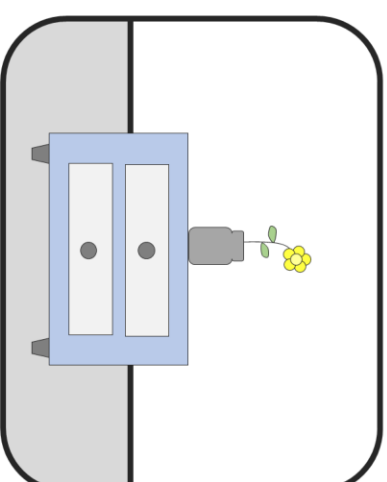

Name: _____

**STICK THE
CORRECT
SENTENCE BELOW
THE IMAGE**

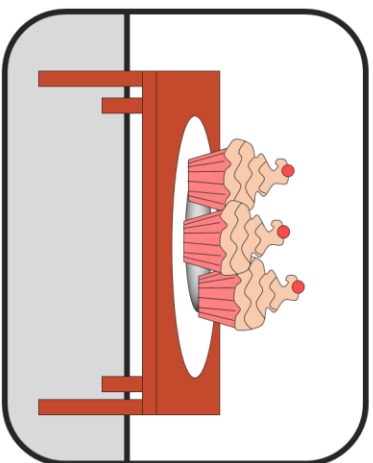
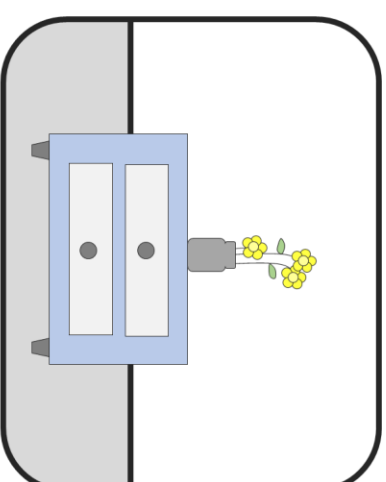
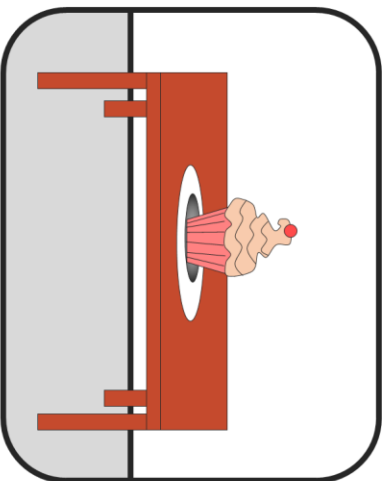

Name: _____

**STICK THE
CORRECT
SENTENCE BELOW
THE IMAGE**

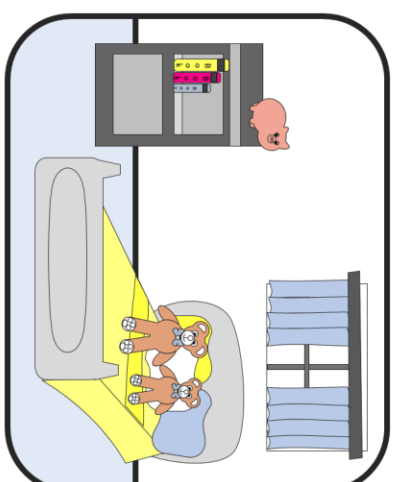
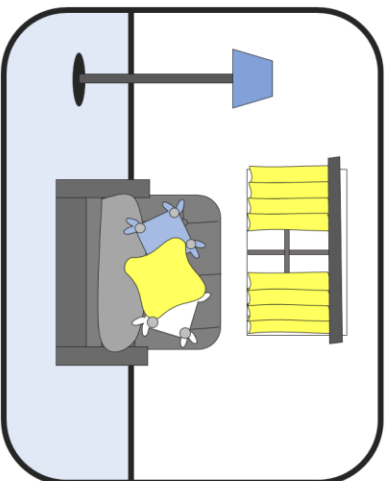

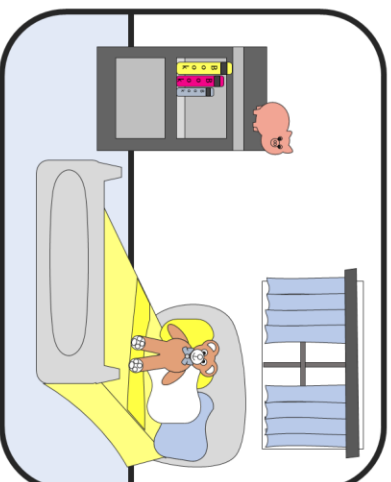
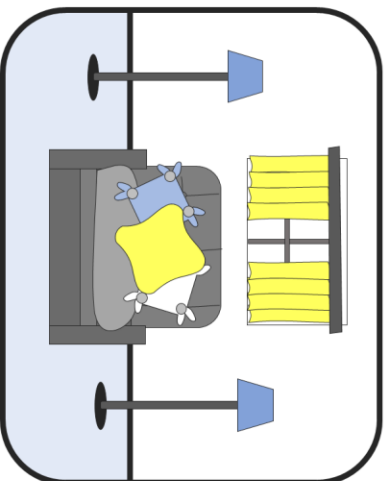

Name: _____

**STICK THE
CORRECT
SENTENCE BELOW
THE IMAGE**

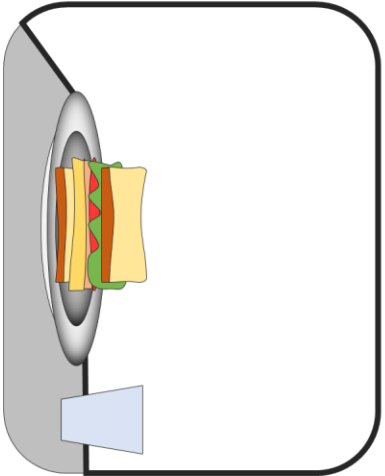

Blank rounded rectangular box for writing a sentence.

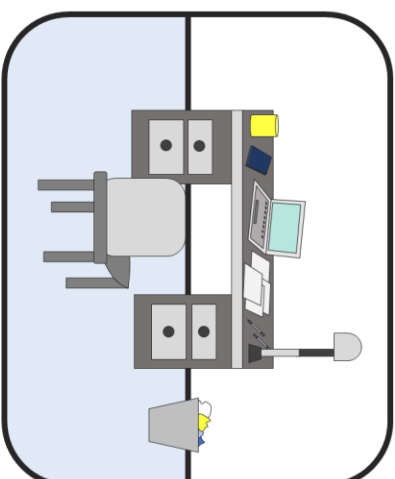

Blank rounded rectangular box for writing a sentence.

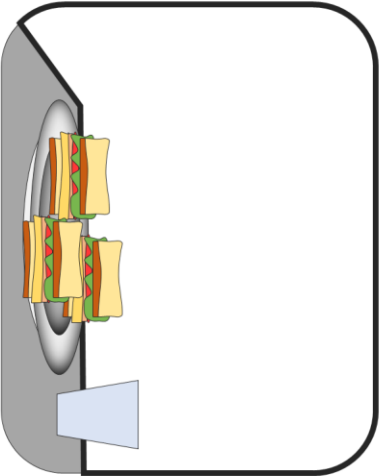

Blank rounded rectangular box for writing a sentence.

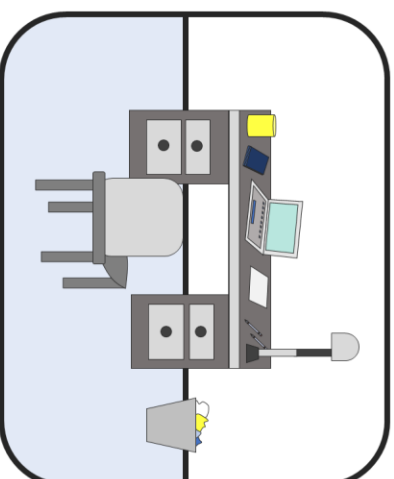

Blank rounded rectangular box for writing a sentence.

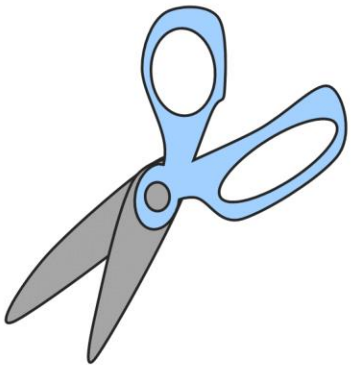

**CUT OUT THESE
SENTENCES AND
STICK THEM WHERE
THEY BELONG**



There is a teddy bear on the bed.

There is a cupcake on the table.

There is a lamp on the floor.

There are two teddy bears on the bed.

There are three cupcakes on the table.

There are two lamps on the floor.



**CUT OUT THESE
SENTENCES AND
STICK THEM WHERE
THEY BELONG**



There is a flower in the vase.

There is a sandwich on the table.

There is a sheet of paper on the desk.

There are three flowers in the vase.

There are three sandwiches on the table.

There are four sheets of paper on the desk.

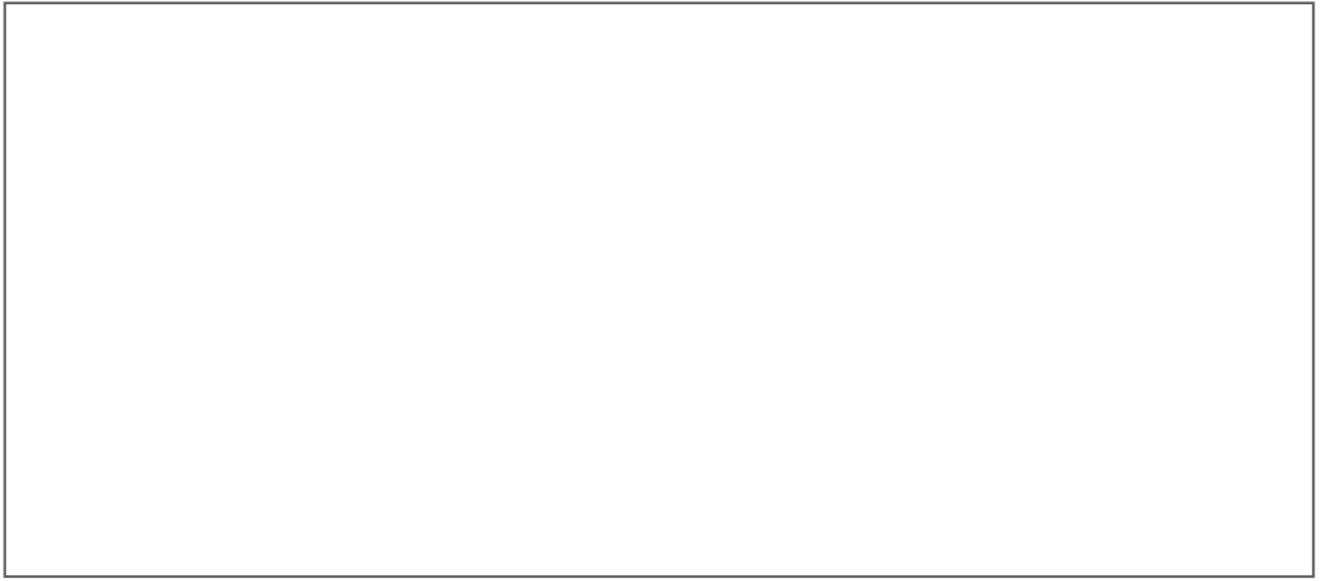

Cut Out And Stick

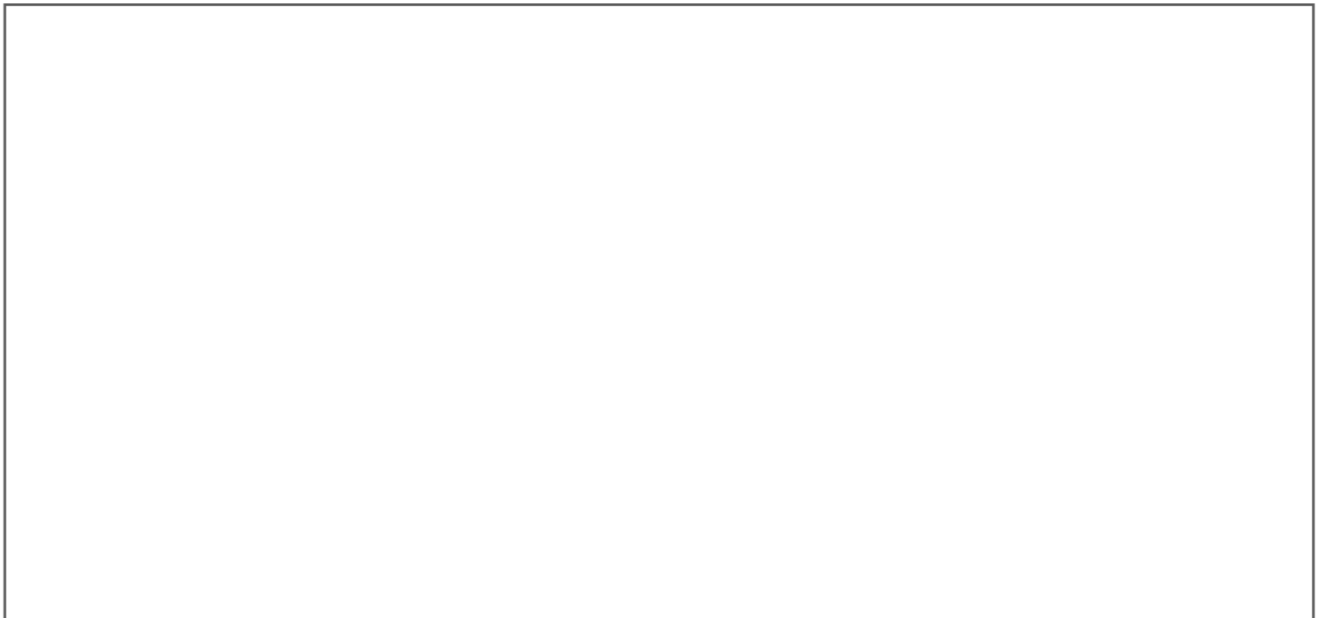

Name: _____

**STICK THE
CORRECT
SENTENCE BELOW
THE IMAGE**

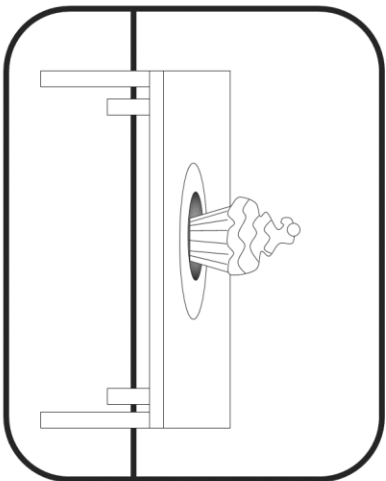

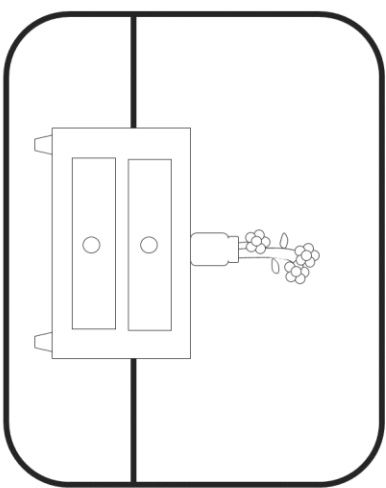

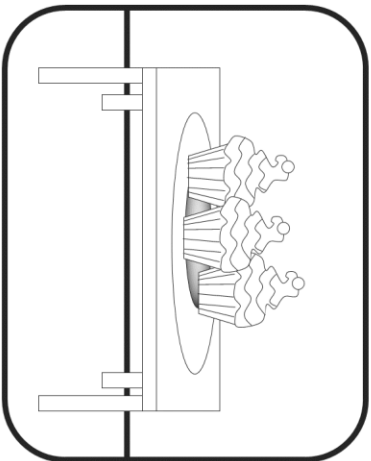

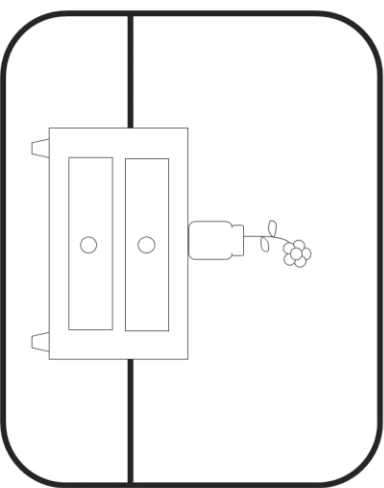

Name: _____

**STICK THE
CORRECT
SENTENCE BELOW
THE IMAGE**

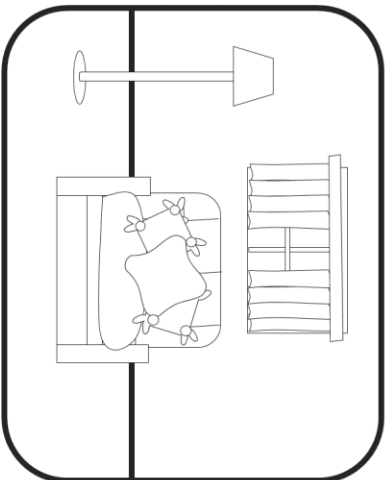

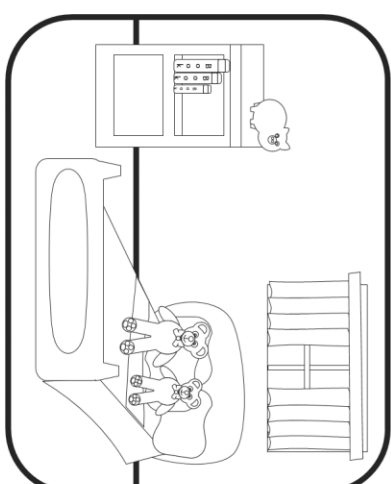

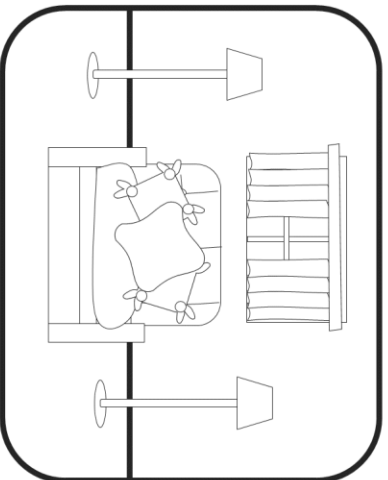

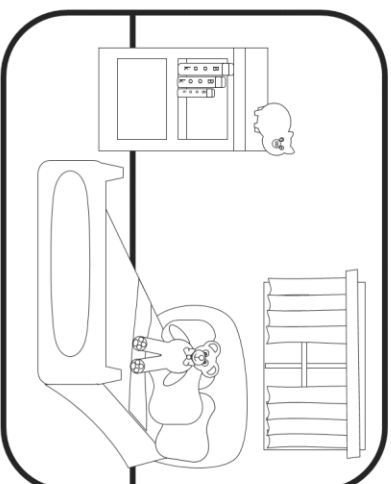

Name: _____

**STICK THE
CORRECT
SENTENCE BELOW
THE IMAGE**

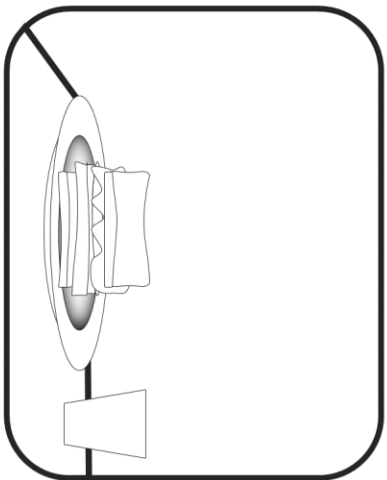

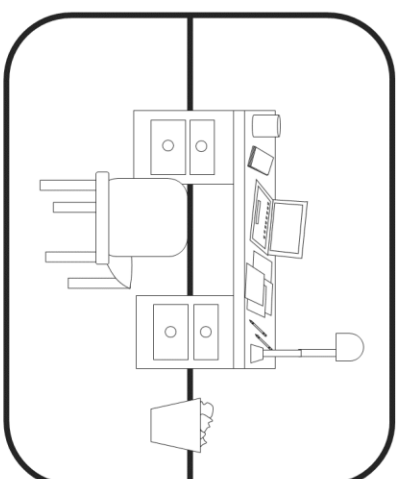

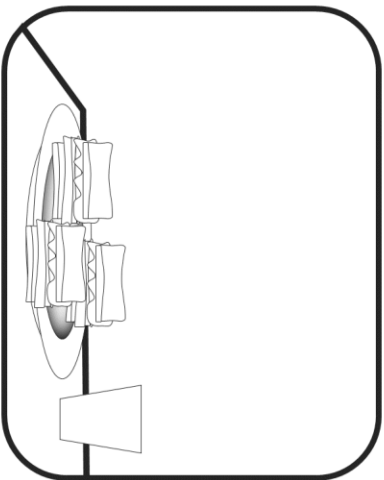

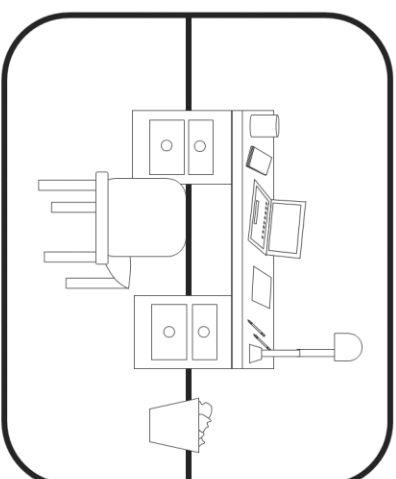

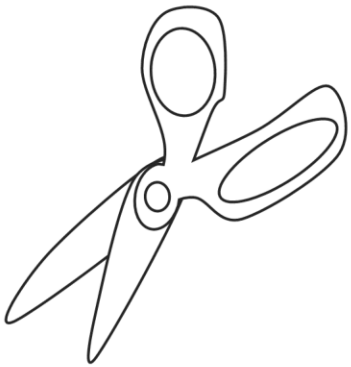

**CUT OUT THESE
SENTENCES AND
STICK THEM WHERE
THEY BELONG**

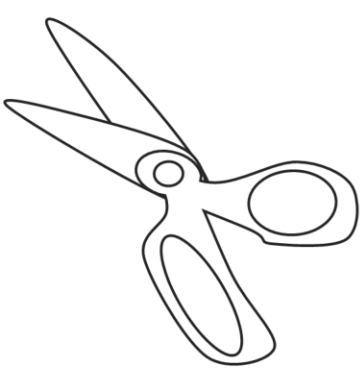

There is a teddy bear on the bed.

There is a cupcake on the table.

There is a lamp on the floor.

There are two teddy bears on the bed.

There are three cupcakes on the table.

There are two lamps on the floor.

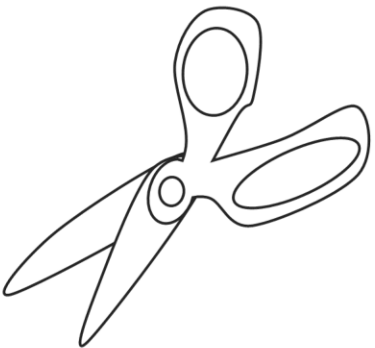

**CUT OUT THESE
SENTENCES AND
STICK THEM WHERE
THEY BELONG**

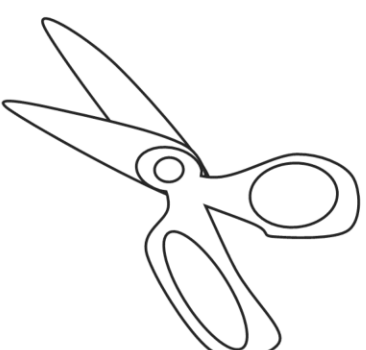

There is a flower in the vase.

There is a sandwich on the table.

There is a sheet of paper on the desk.

There are three flowers in the vase.

There are three sandwiches on the table.

There are four sheets of paper on the desk.