

FLASHCARDS



VOCABULARY

CLOTHES

Flashcards

CLOTHES

Here you have the 12 clothes themed flashcards (color and black and white version).

Print them on cardstock, cut them out and that's it, you have them ready to use!

You can also laminate them for more durability.

If you have any questions, suggestions or feedback, please, don't hesitate to contact us, we'll be happy to help you!

Here's our email:

perkylearning@gmail.com

Have a nice day!

Becca

CUT ALONG THE DOTTED LINES

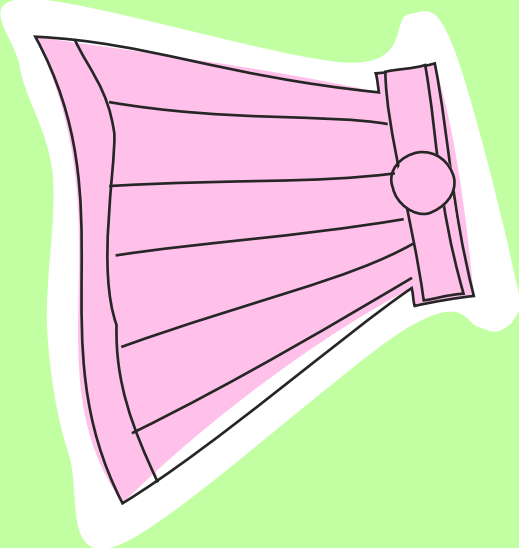

SKIRT

©Perky Learning

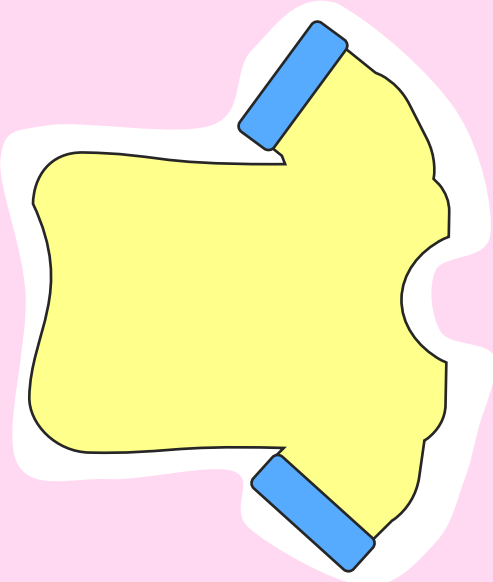

T-SHIRT

©Perky Learning

CUT ALONG THE DOTTED LINES

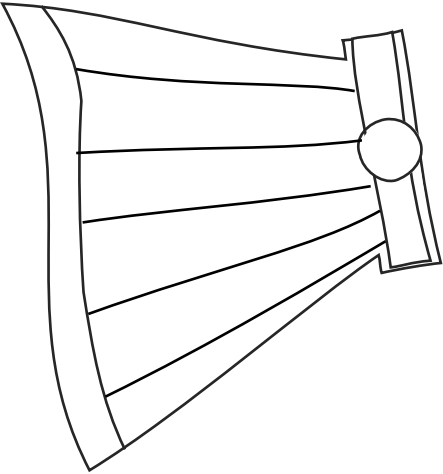

SKIRT

©Perky Learning

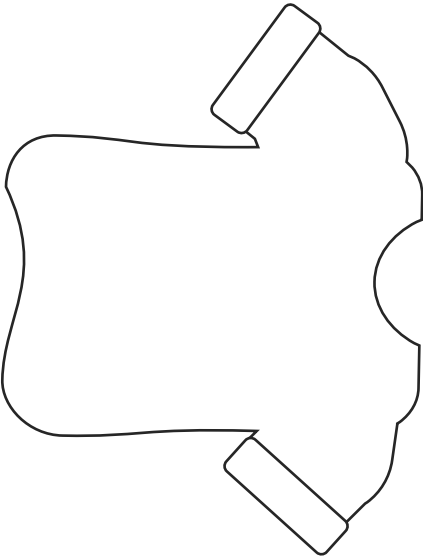

T-SHIRT

©Perky Learning

CUT ALONG THE DOTTED LINES

GLOVES

©Perky Learning



HAT

©Perky Learning

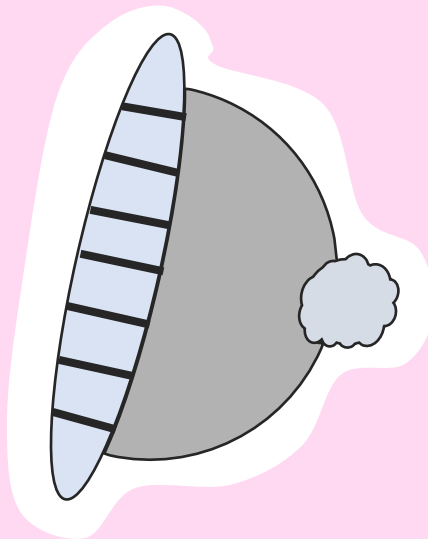

CUT ALONG THE DOTTED LINES

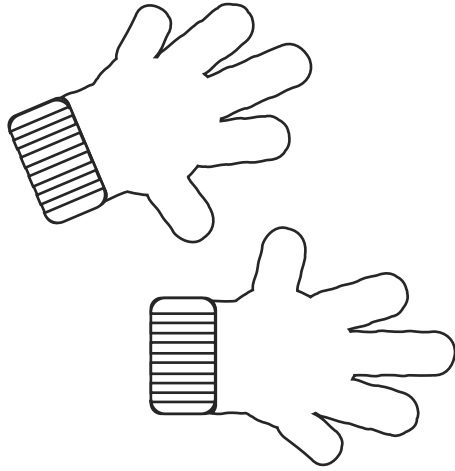

GLOVES

©Perky Learning

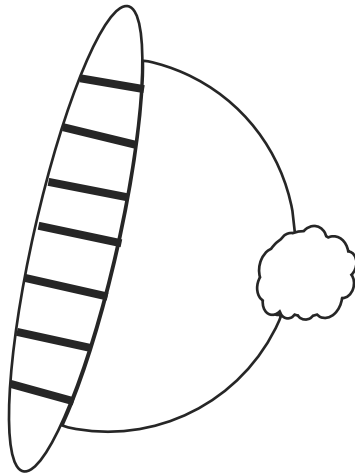

HAT

©Perky Learning

CUT ALONG THE DOTTED LINES

PANTS

©Perky Learning

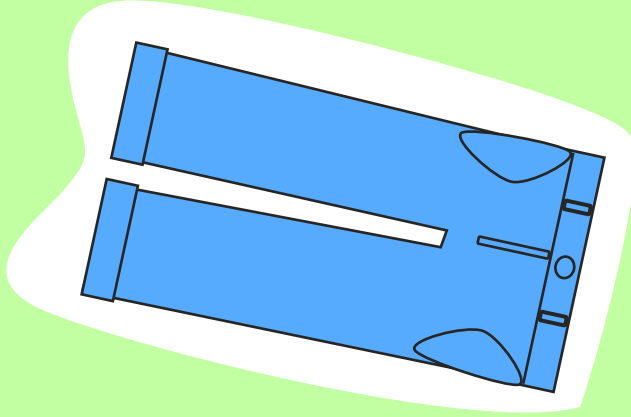

SHOES

©Perky Learning



CUT ALONG THE DOTTED LINES

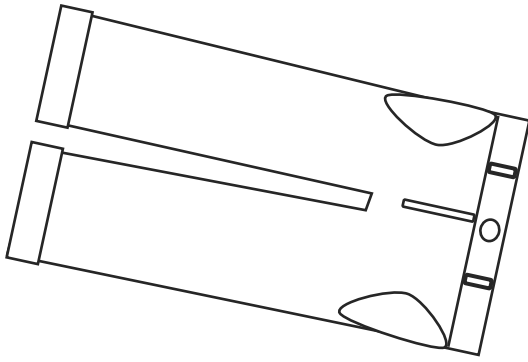

PANTS

©Perky Learning

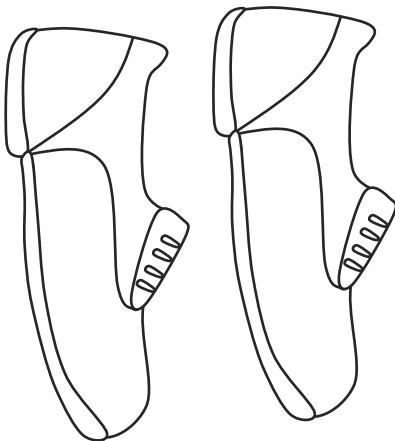

SHOES

©Perky Learning

CUT ALONG THE DOTTED LINES

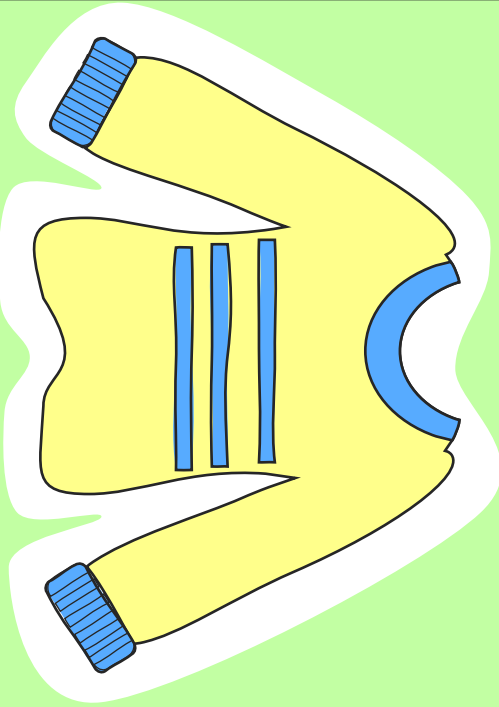

SWEATER

©Perky Learning

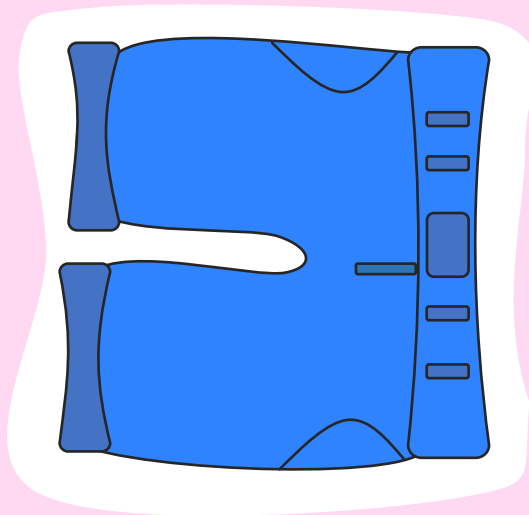

SHORTS

©Perky Learning

CUT ALONG THE DOTTED LINES

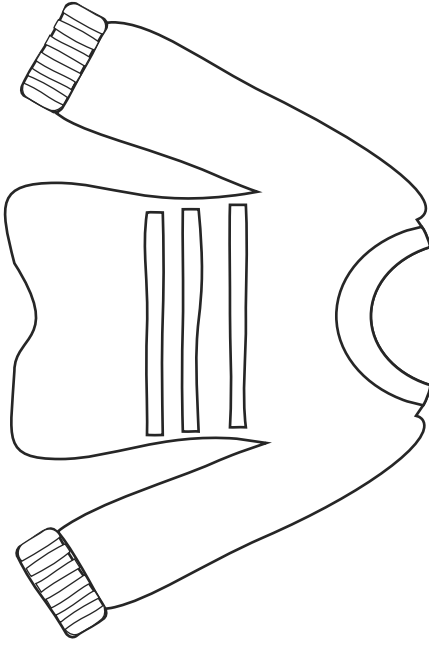

SWEATER

©Perky Learning

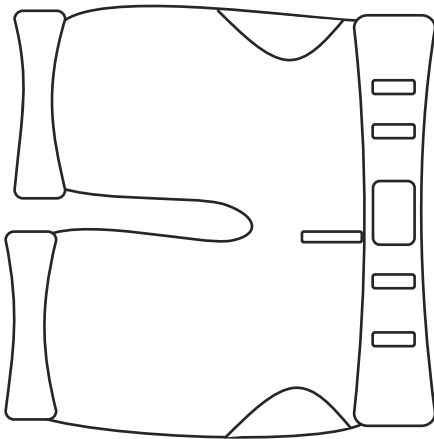

SHORTS

©Perky Learning

CUT ALONG THE DOTTED LINES

©Perky Learning

DRESS

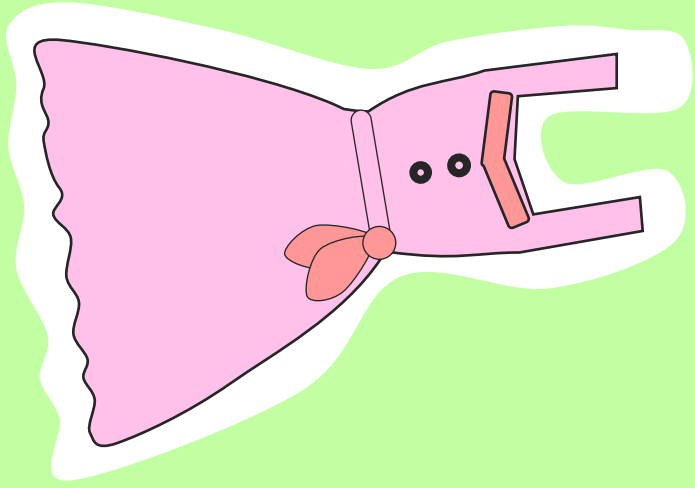

©Perky Learning

SOCKS

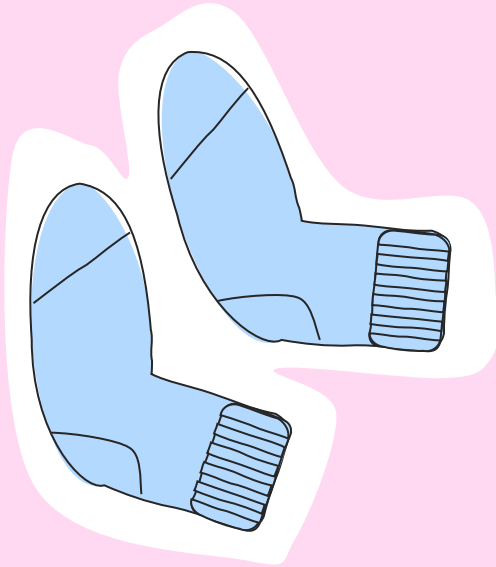

CUT ALONG THE DOTTED LINES

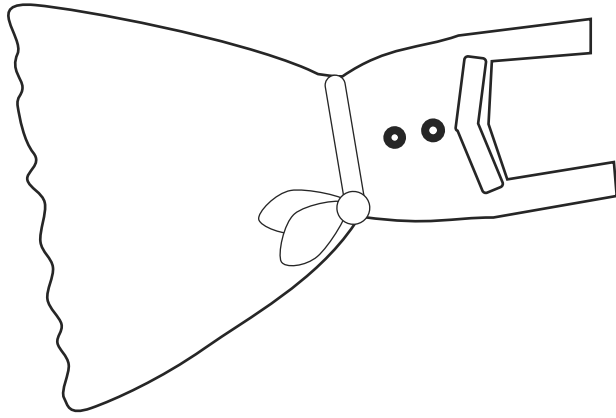

DRESSES

©Perky Learning

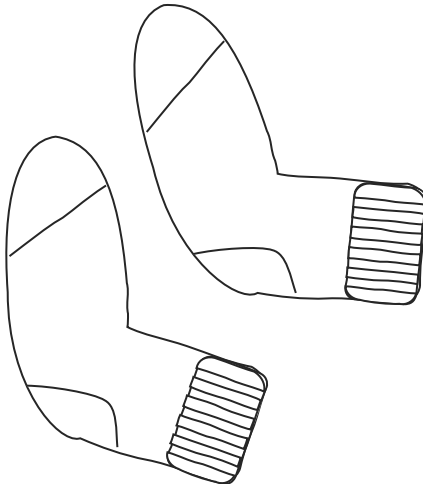

SOCKS

©Perky Learning

CUT ALONG THE DOTTED LINES

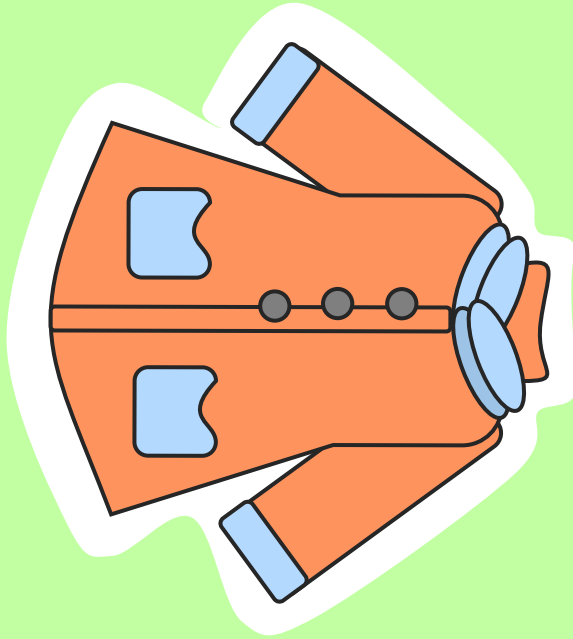

COAT

©Perky Learning

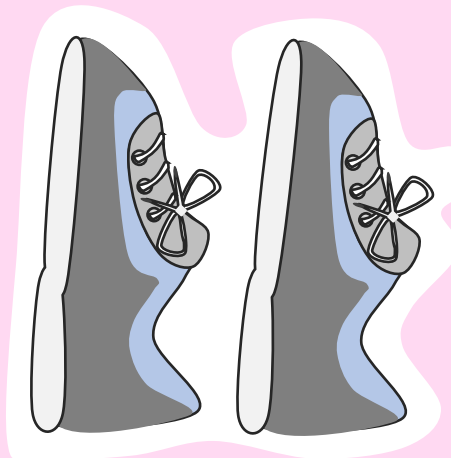

SNEAKERS

©Perky Learning

CUT ALONG THE DOTTED LINES

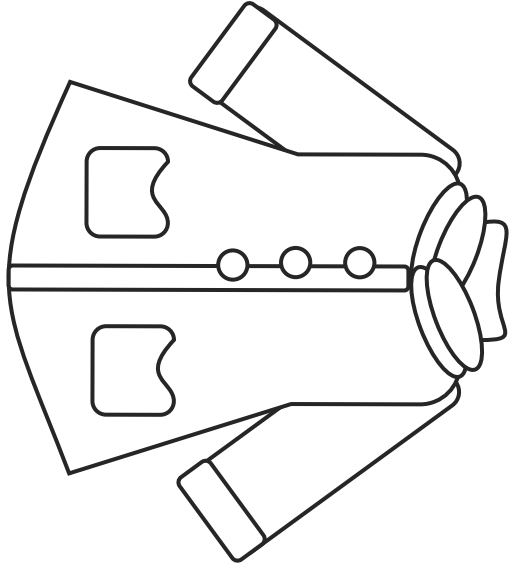

COAT

©Perky Learning

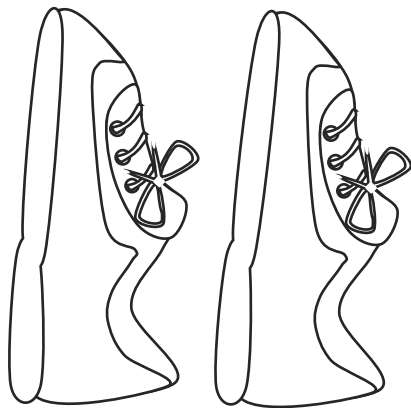

SNEAKERS

©Perky Learning